

# MAG TRACK

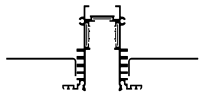

## TRIMLESS



The installation may only be carried out by a technician  
 Nur ein Techniker kann die Installation durchführen  
 Instalaci smí provádět pouze technik  
 Inštaláciu môže vykonať iba technik

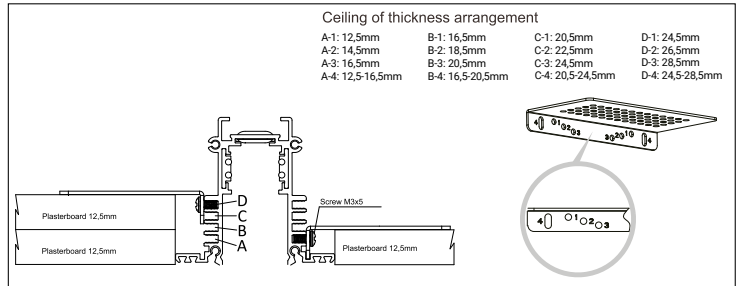
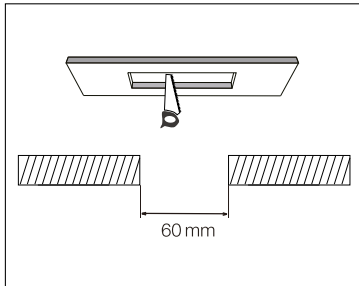
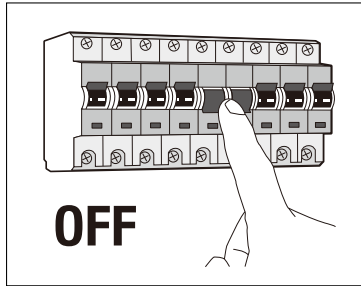
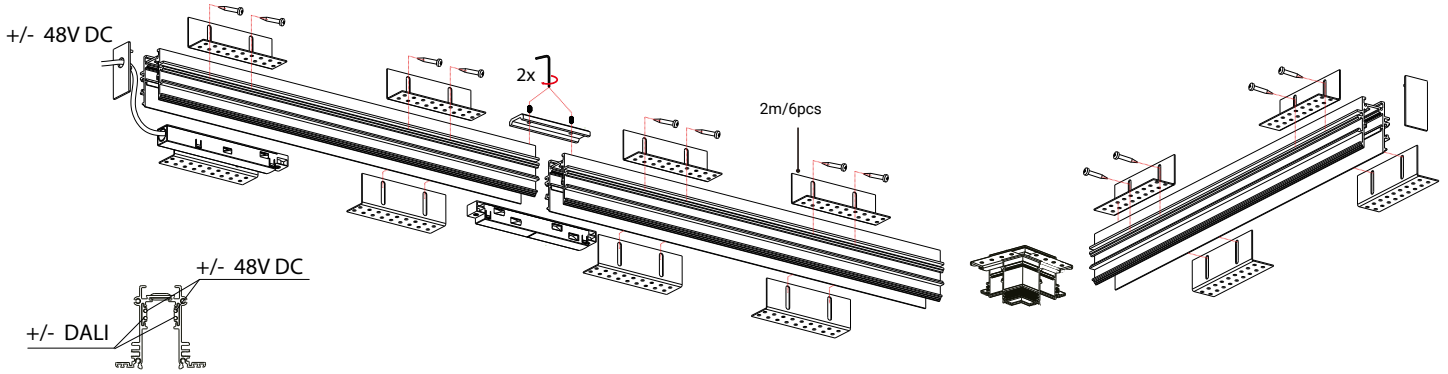

**Version A**  
external driver

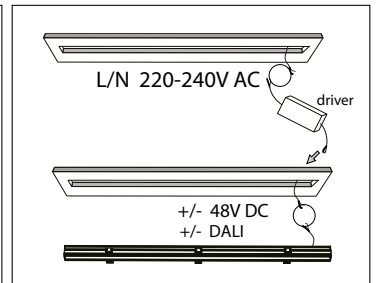
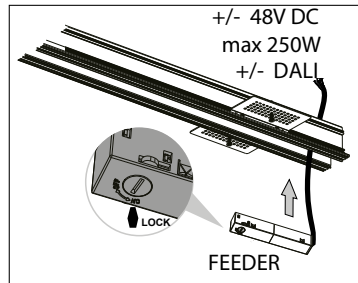
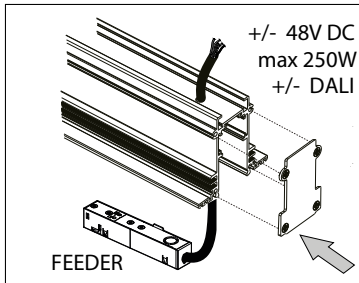

**Version B**  
internal driver

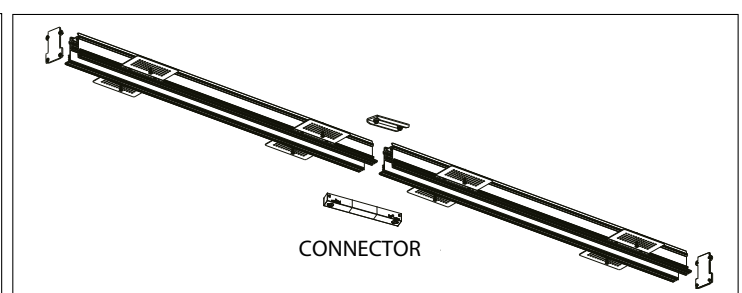
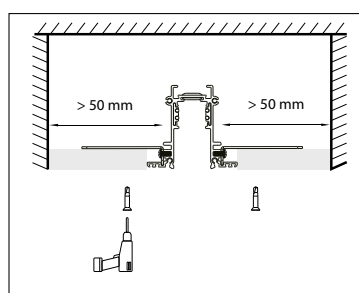
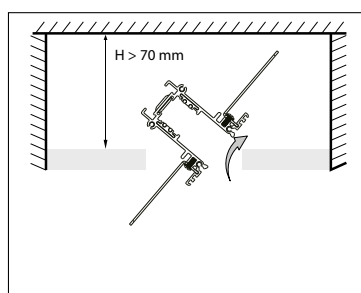
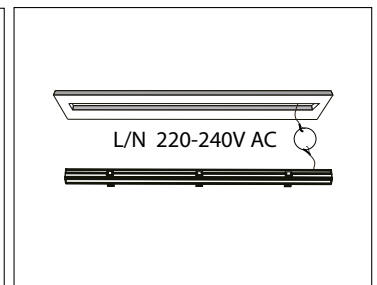
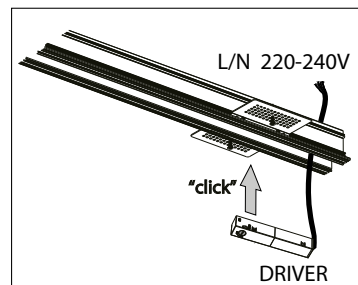
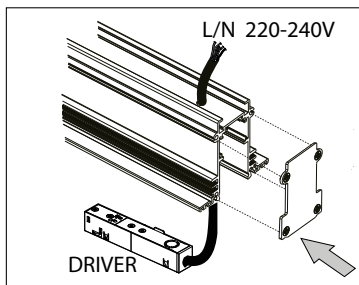

# MAG TRACK

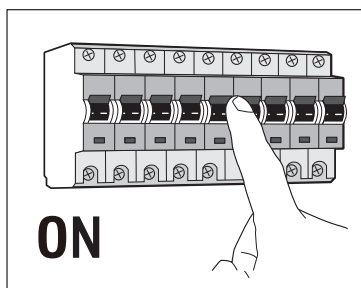
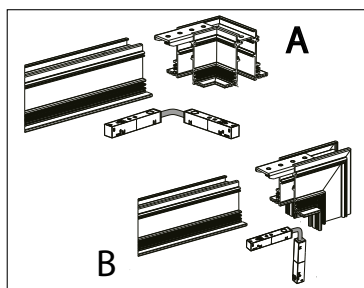
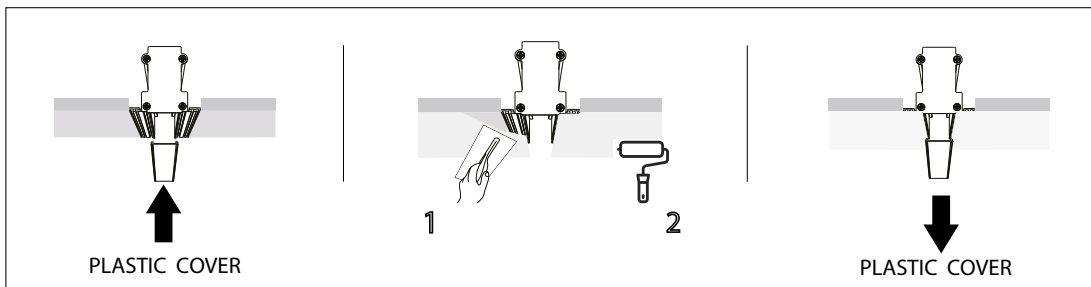
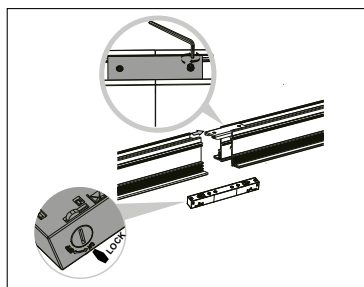

# MAG TRACK

## SURFACE



The installation may only be carried out by a technician  
Nur ein Techniker kann die Installation durchführen  
Instalaci smí provádět pouze technik  
Inštaláciu môže vykonať iba technik

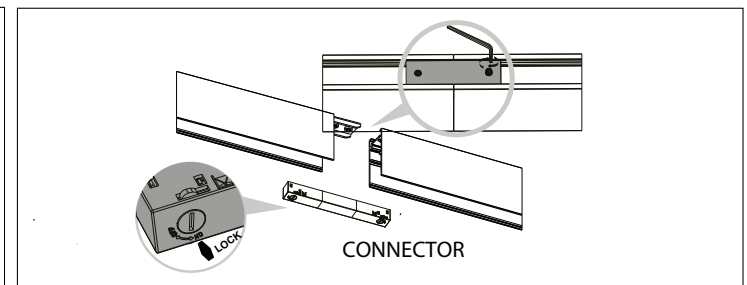
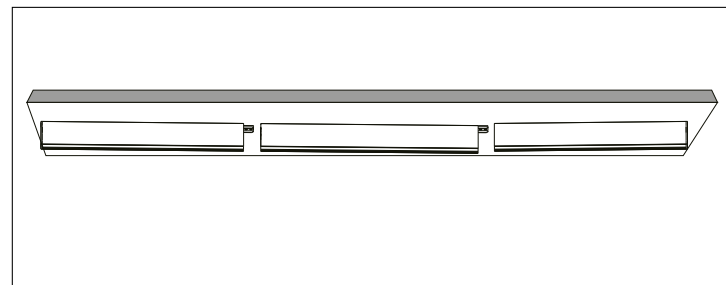
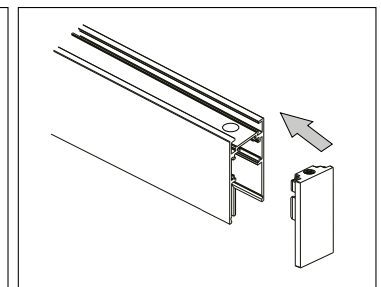
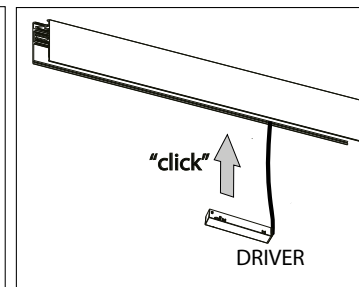
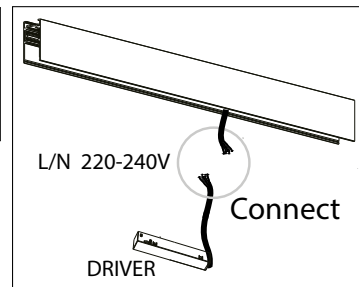
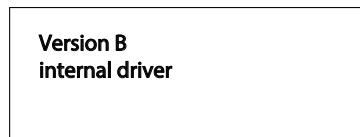
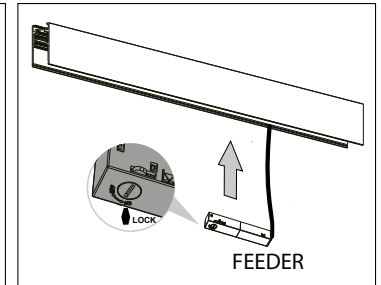
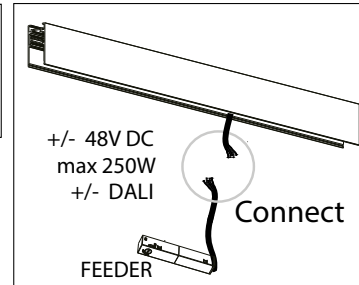
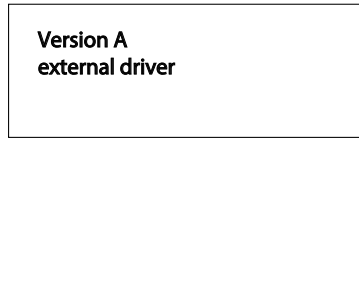
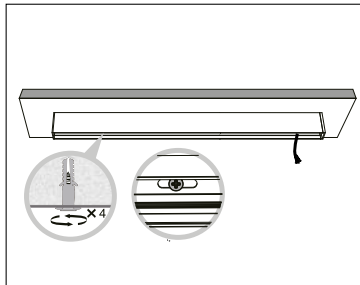
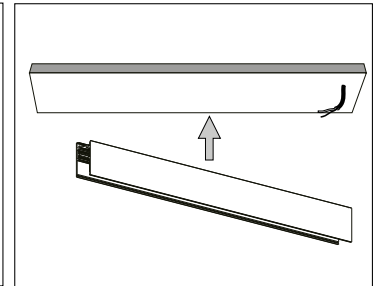
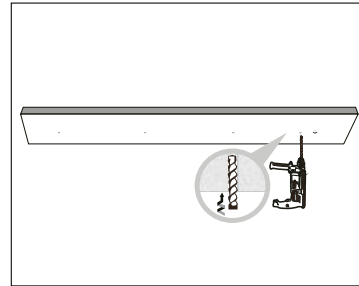
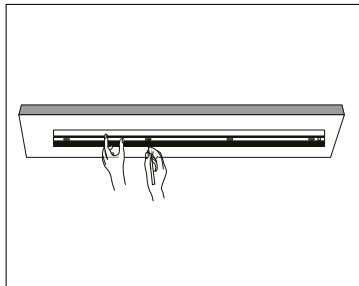
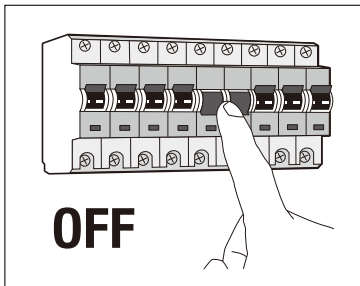
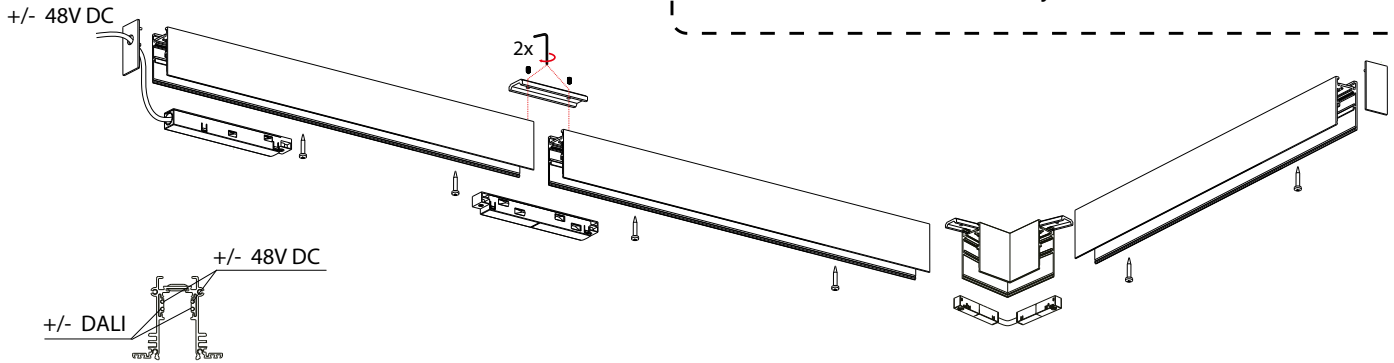

# MAG TRACK

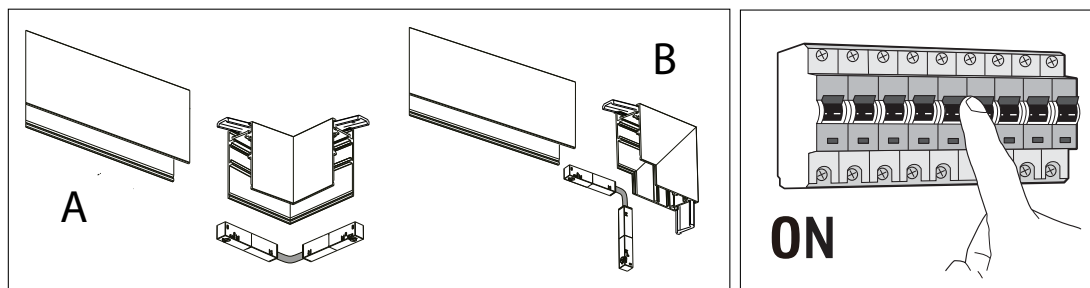

EN: pre-prepared holes - surface mounting  
DE: vorgefertigte Löcher - Oberflächen-Montage  
CZ: předpřipravené otvory - montáž na povrch  
SK: predpripravené otvory - montáž na povrch

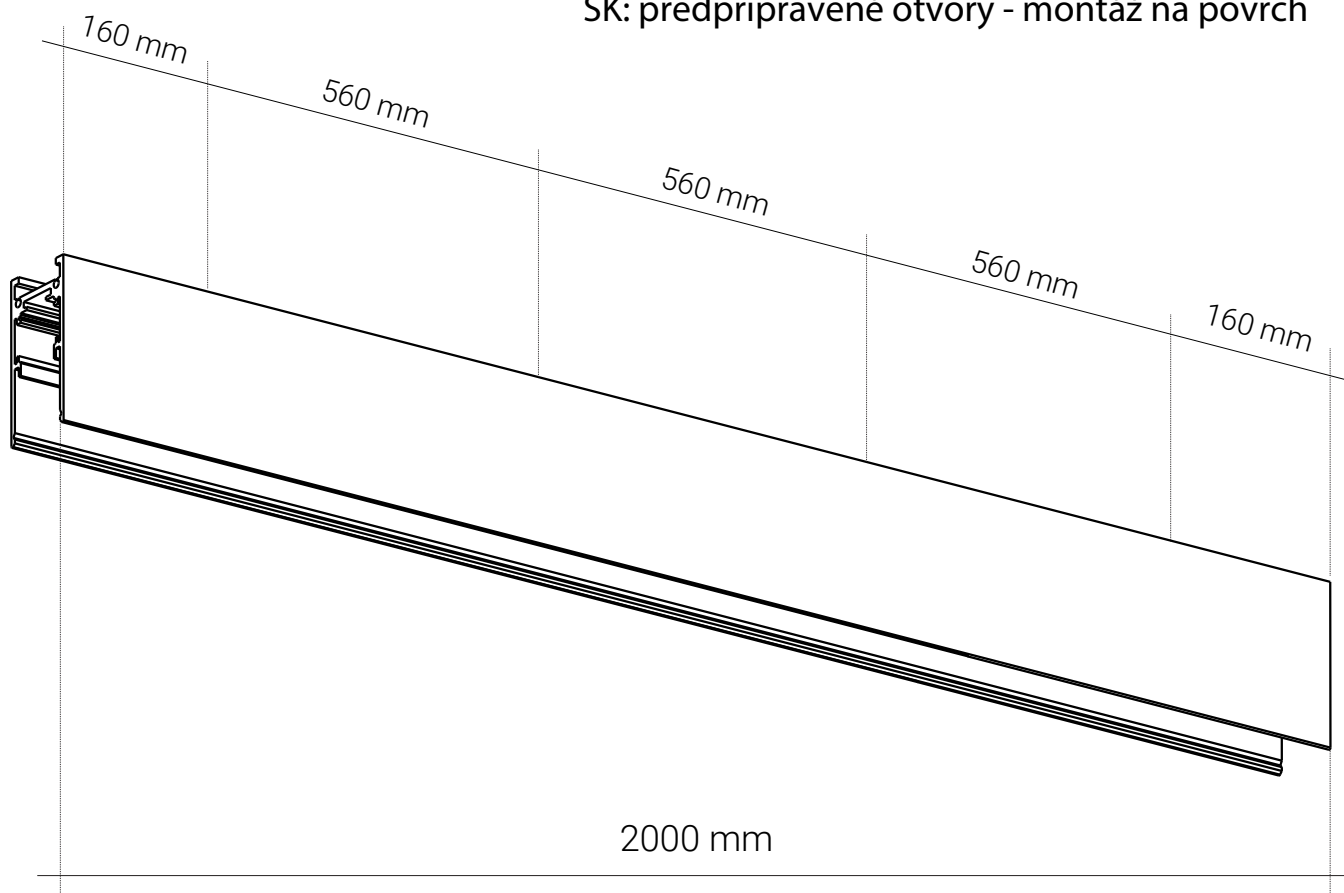

# MAG TRACK

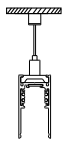

## SUSPENDED



The installation may only be carried out by a technician  
 Nur ein Techniker kann die Installation durchführen  
 Instalaci smí provádět pouze technik  
 Inštaláciu môže vykonať iba technik

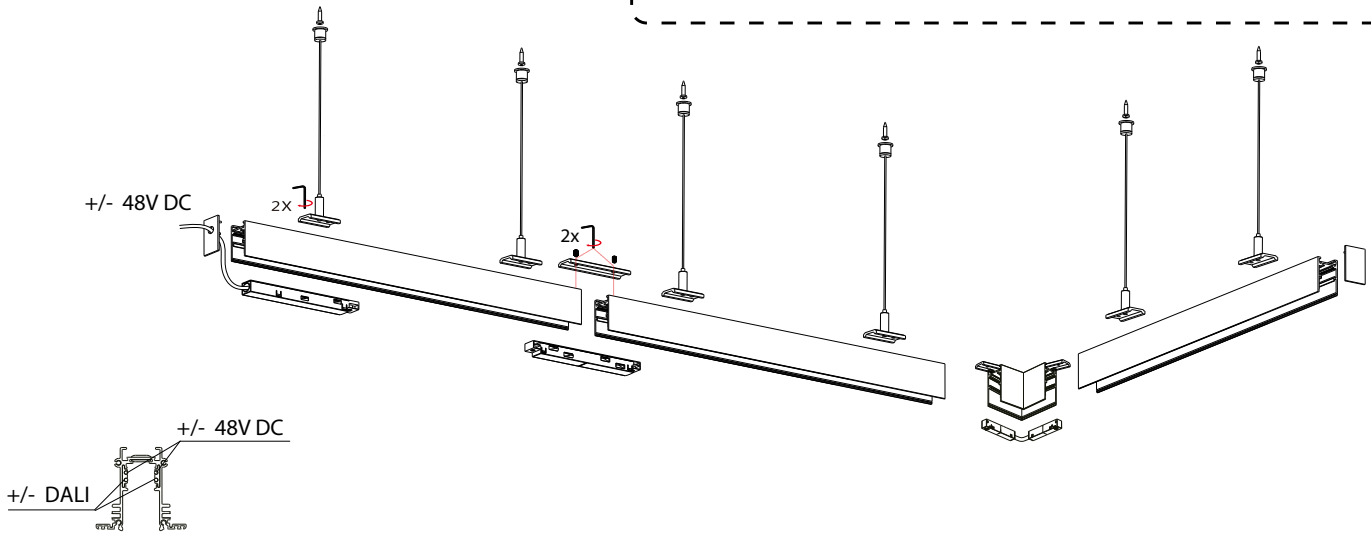

<p><b>OFF</b></p>	<p>1</p> <p>2</p>		
			<p>2x</p>
<p>Version A external driver</p>	<p>+/- 48V DC</p> <p>1</p> <p>+ + +</p> <p>- - -</p> <p>+/- DALI</p> <p>2</p> <p>cable</p>	<p>+/- 48V DC max 250W +/- DALI</p> <p>Connect</p> <p>FEEDER</p>	<p>FEEDER</p>

# MAG TRACK

Version B  
internal driver

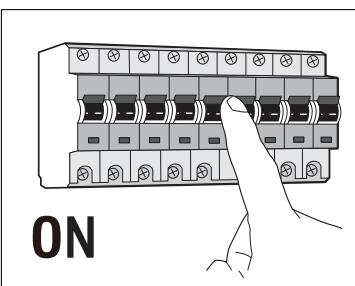
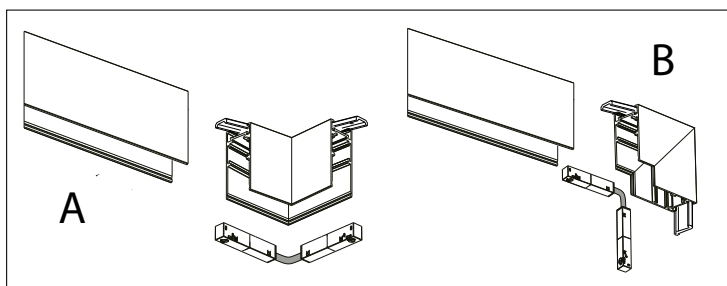
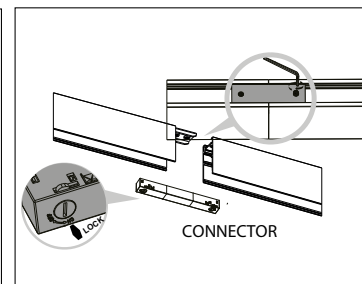
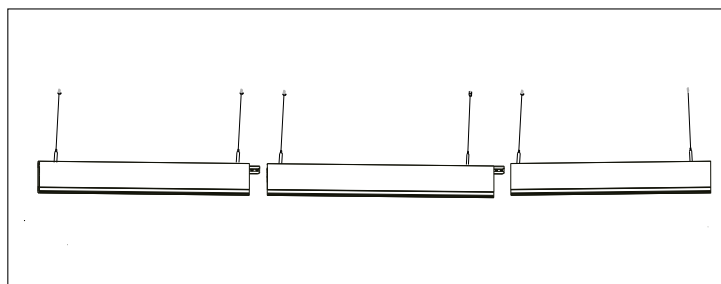
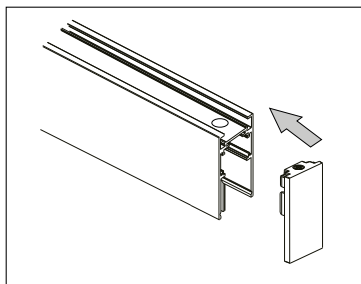
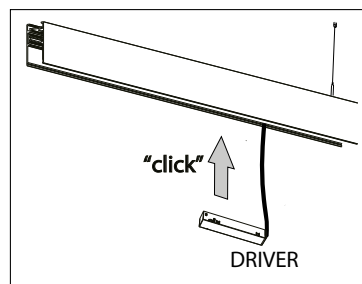
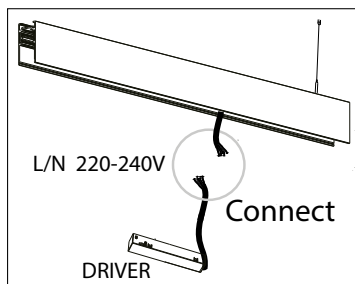
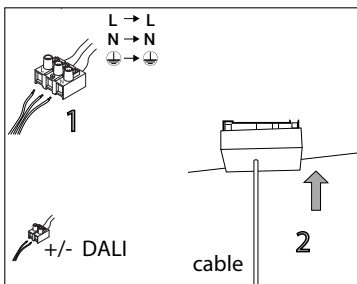

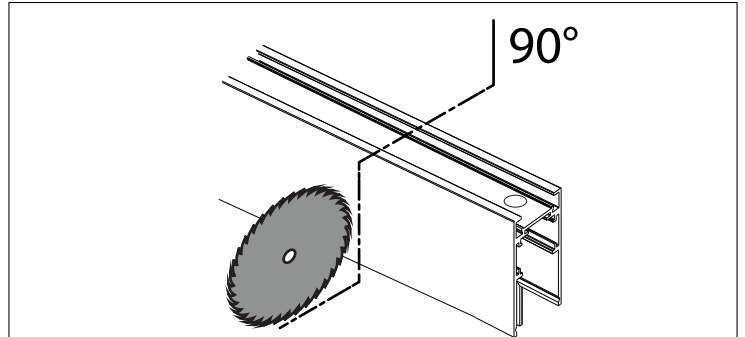
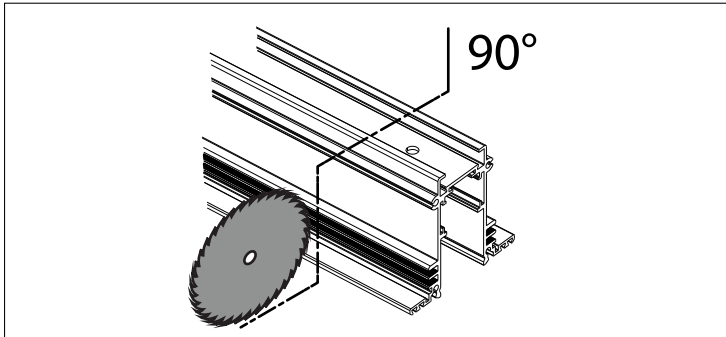
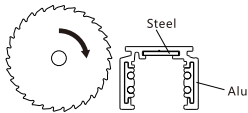

## CONNECTION - VERBINDUNG- ZAPOJENIE- ZAPOJENÍ

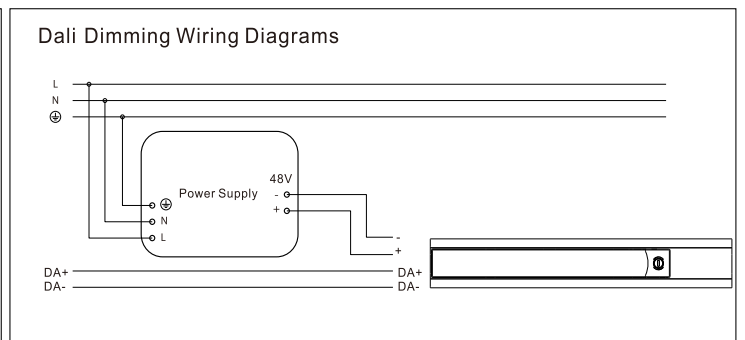
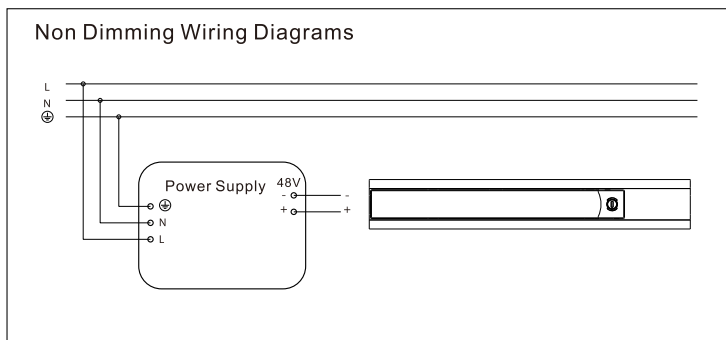

### (EN) CAUTION!

Turn off the main power before proceeding with the installation in order to prevent possible shock. The installation may only be carried out by a technician or a qualified person. If the lamp has a lampshade/diffuser, handle it carefully as it is fragile. With an integrated LED light source, only a technician or a qualified person can make the replacement. The manufacturer is not responsible for the incorrect use and assembly of its products.

### (DE) ACHTUNG!

Vor der Installation ist es notwendig, den Hauptstromkreis zu unterbrechen, um ein Stromschlag zu vermeiden. Die Installation darf nur von einem Techniker oder einer qualifizierten Person durchgeführt werden. Wenn die Lampe einen Lampenschirm/Diffuser hat, gehen Sie vorsichtig damit um, da sie zerbrechlich ist. Mit einer integrierten LED-Lichtquelle kann nur ein Techniker oder eine qualifizierte Person den Austausch vornehmen. Der Hersteller ist nicht verantwortlich für die fehlerhafte Verwendung und Montage seiner Produkte.

### (SK) UPOZORNENIE!

Pred inštaláciou je nevyhnutné odpojiť hlavný elektrický okruh, aby ste predišli zasiahnutiu elektrickým prúdom. Montáž môže vykonať iba kvalifikovaná osoba. V prípade, že má svietidlo tienidlo/difúzor, narábajte s ním opatrne, pretože je krehké. Pri integrovanom LED svetelnom zdroji môže výmenu zrelizovať iba technik alebo kvalifikovaná osoba. Výrobca nenesie zodpovednosť za nesprávne zachádzanie s produktom.

### (CZ) UPOZORNĚNÍ!

Před instalací je nutné odpojit hlavní elektrický okruh, abyste předešli zasažení elektrickým proudem. Montáž může provádět pouze kvalifikovaná osoba. V případě, že má svítidlo stínidlo/difuzor, zacházejte s ním opatrně, protože je křehké. Při integrovaném LED světelném zdroji může výměnu zrelizovat pouze technik nebo kvalifikovaná osoba. Výrobce nenes odpovědnost za nesprávné zacházení s výrobkem.

