



Paulmann



Info

www.paulmann.com

Paulmann Licht GmbH  
Quezinger Feld 2  
31832 Springe  
Germany

www.paulmann.com

Art.-Nr.:953.88

PYN 07/22



NiMH

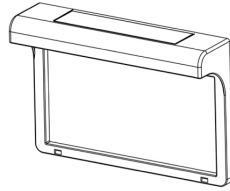

12345

67890

2x

ABCDE

1x



incl

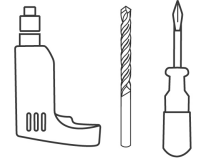

A

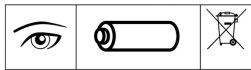
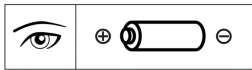
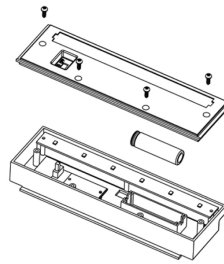
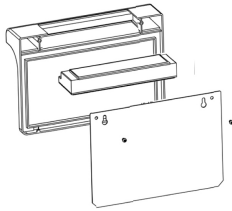

only use rechargeable 1xNi-MH AA Battery (DC 1.2V,600mAh)

B

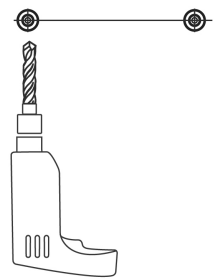

C

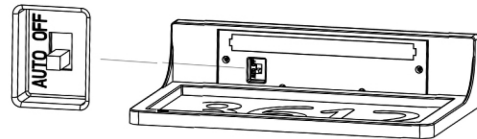
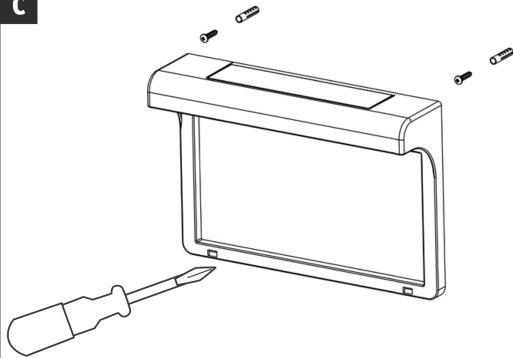

6-8h



4-6h



6-8h



< 4h



= D Altgeräte dürfen nicht in den Restmüll. Sie können bei öffentlichen Sammelstellen von Entsorgungsträgern abgegeben werden. Altbatterien und Altakkumulatoren, sowie Lampen, die zerstörungsfrei aus dem Altgerät entnommen werden können, sind vor der Abgabe an eine Erfassungsstelle von dem Altgerät zu trennen. Vertrieber sind im Rahmen von § 17 Absatz 1 und 2 ElektroG zur unentgeltlichen Rücknahme dieses Produktes verpflichtet. Endnutzer von Altgeräten müssen eigenverantwortlich für die Löschung personenbezogener Daten auf den zu entsorgenden Altgeräten sorgen.

www.paulmann.com