

W 6 W
 lm 650 Lumen
 t 20000 h
 T_K 3000 Kelvin
 15000 x
 <0.5s

829117

230V / 50Hz

LED

1xLED-Board Max6W

A

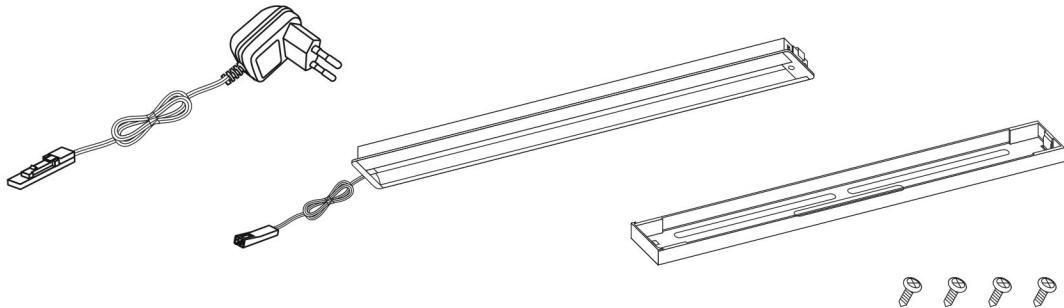

B

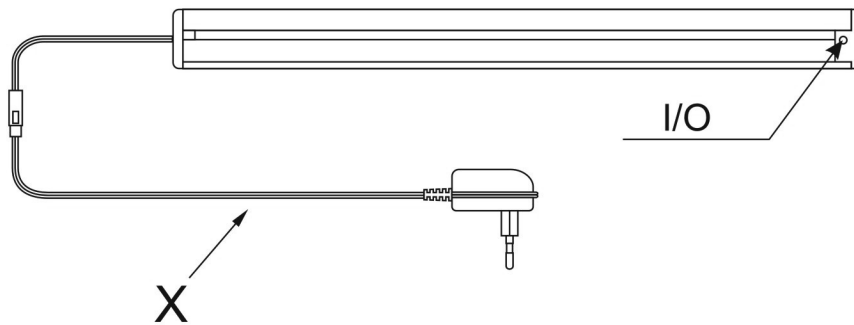

C

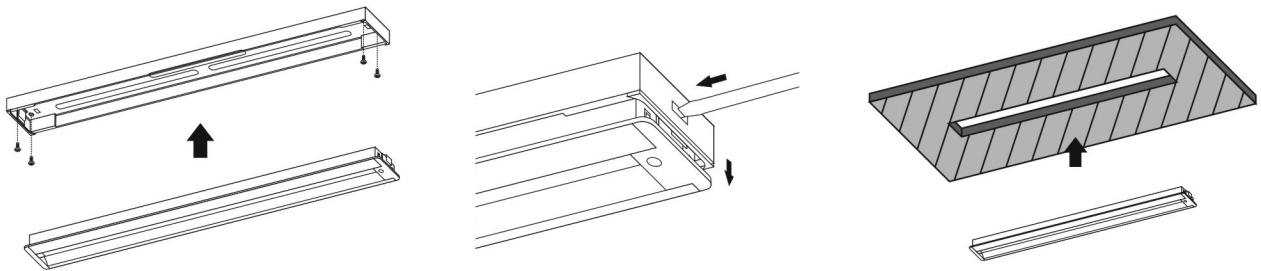

D

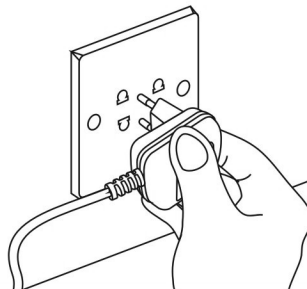

Bitte geben Sie bei technischen Fragen die chargennummer(xxxx-xx-xx-xxxx-xxxx) an.Diese finden Sie auf dem Typenschild.

Please let us know the batch number (xxxx-xx-xx-xxxx-xxxx) for any technical questions. This can be found on the rating label.

Lors de demande d'assistance technique, veuillez indiquer le numéro du lot (xxxx-xx-xx-xxxx-xxxx). Celui-ci se trouve sur la plaque d'identification.

06/2016

Paul Neuhaus

Paul Neuhaus GmbH
 Olakenweg 36 • 59457 Werl
 Germany